



Bags Making Machine



MTP-IL

In-line fully automatic one track T-shirt bags making machine

MATILA INDUSTRIAL CO., LTD.

No. 186, Chung Hsiao Rd., Pali Dist., New Taipei City, Taiwan 249

Tel: 886-2-2619 2222

Fax: 886-2-2610 1100

Email: matila@matila.com.tw

www.matilataiwan.com

MSE

Luxury non-tension bottom sealing bags making machine

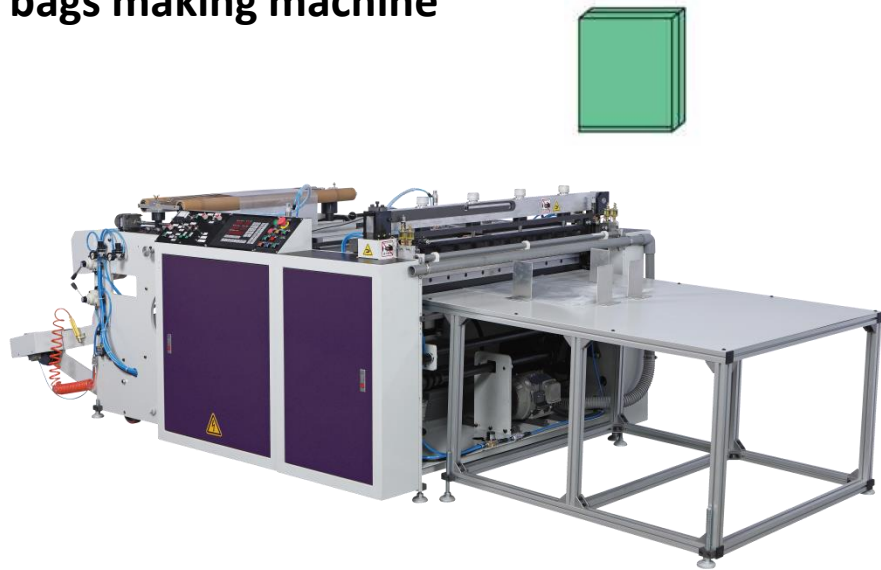

MSES

Luxury non-tension bottom sealing bags making machine (with hot slitter)

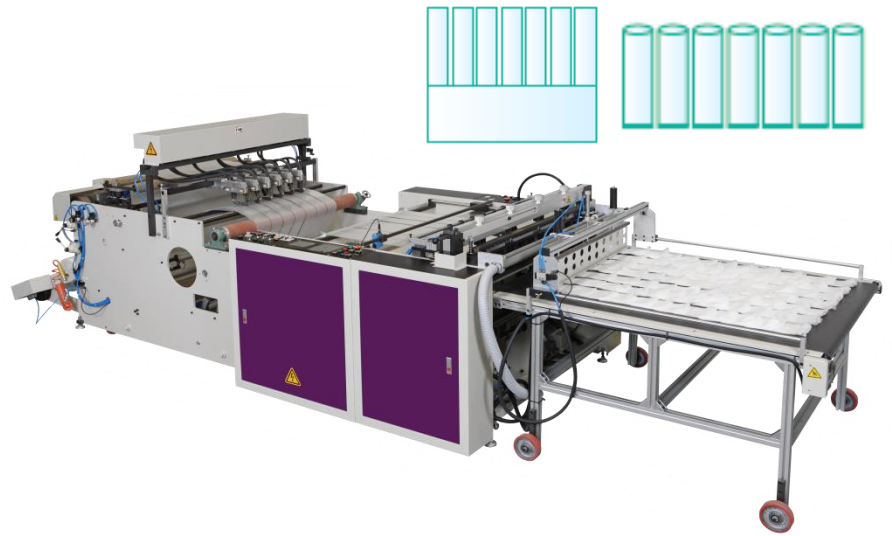

MSE-3F

Luxury non-tension bottom sealing bags making machine (with 3-fold device)

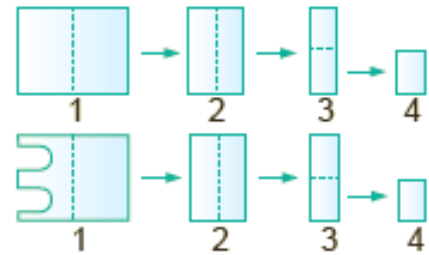

MSE-4F

Luxury non-tension bottom sealing bags making machine (with 4-fold device)

MDL2

Two layer two track flat bags making machine



MDL4

Two layer four track Flat bags/ T-shirt bags making machine

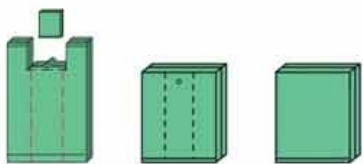

MDL6

Two layer six track Flat bags/ T-shirt bags making machine

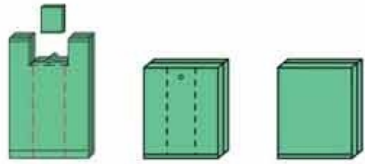

MDL8

Two layer eight track Flat bags/ T-shirt bags making machine

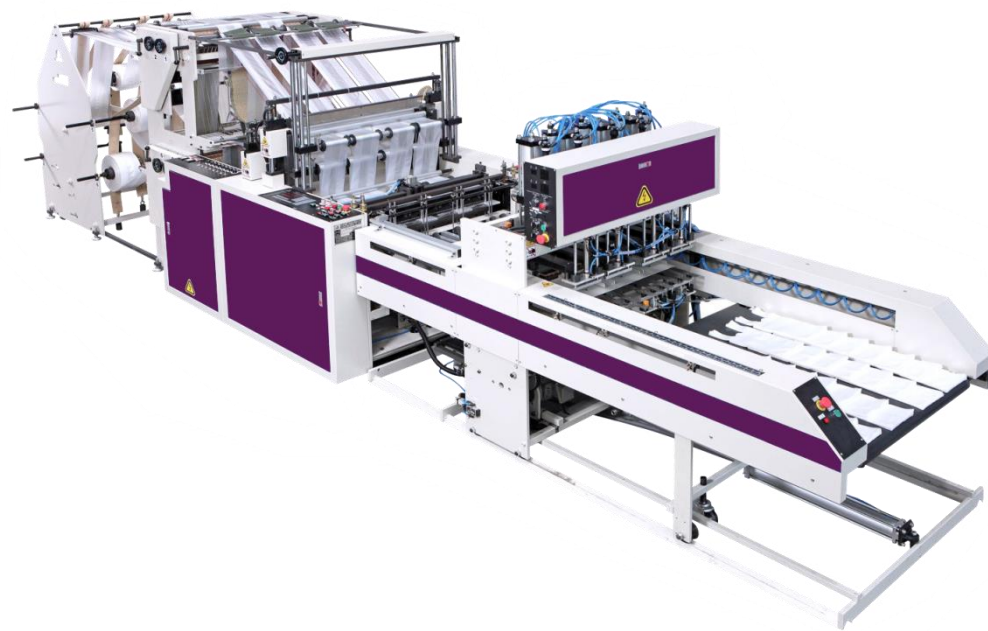
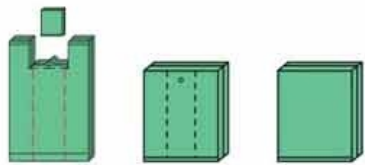

MDLP4

Two layer four track automatic Flat bags/ T-shirt bags making machine

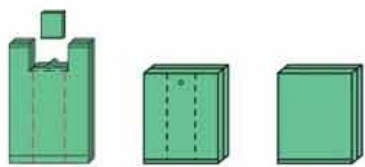

MDLP6

Two layer six track automatic Flat bags/ T-shirt bags making machine

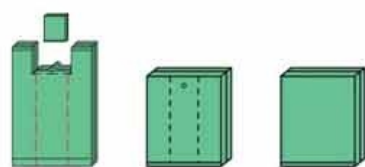

MDLP8

Two layer eight track automatic Flat bags/ T-shirt bags making machine

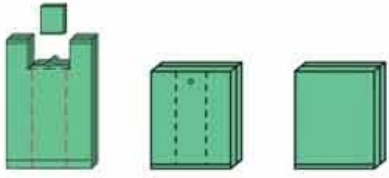

MTP

Fully automatic one track T-shirt bags making machine

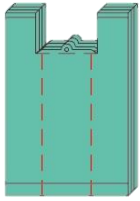

MTTP-SS-200

Fully automatic two track T-shirt bags making machine

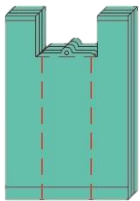

MTTP-SS-250

Fully automatic two track T-shirt bags making machine

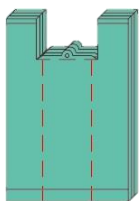

MTTP-SS-300

Fully automatic two track
T-shirt bags making machine

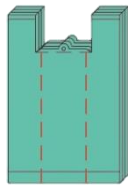

MTTP-SSS-250

Fully automatic three track T-shirt bags
making machine



MTP-ST2-250

Fully automatic T-shirt bags making machine + Hot-slitter & Re-gusset device

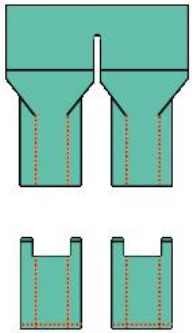

MTP-ST3-250

Fully automatic T-shirt bags making machine + Hot-slitter & Re-gusset device

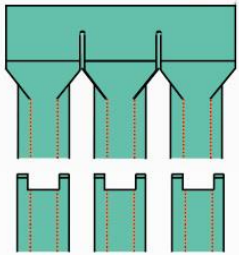

MTP-ST4-250

Fully automatic T-shirt bags making machine + Hot-Slitter & Re-gusset device

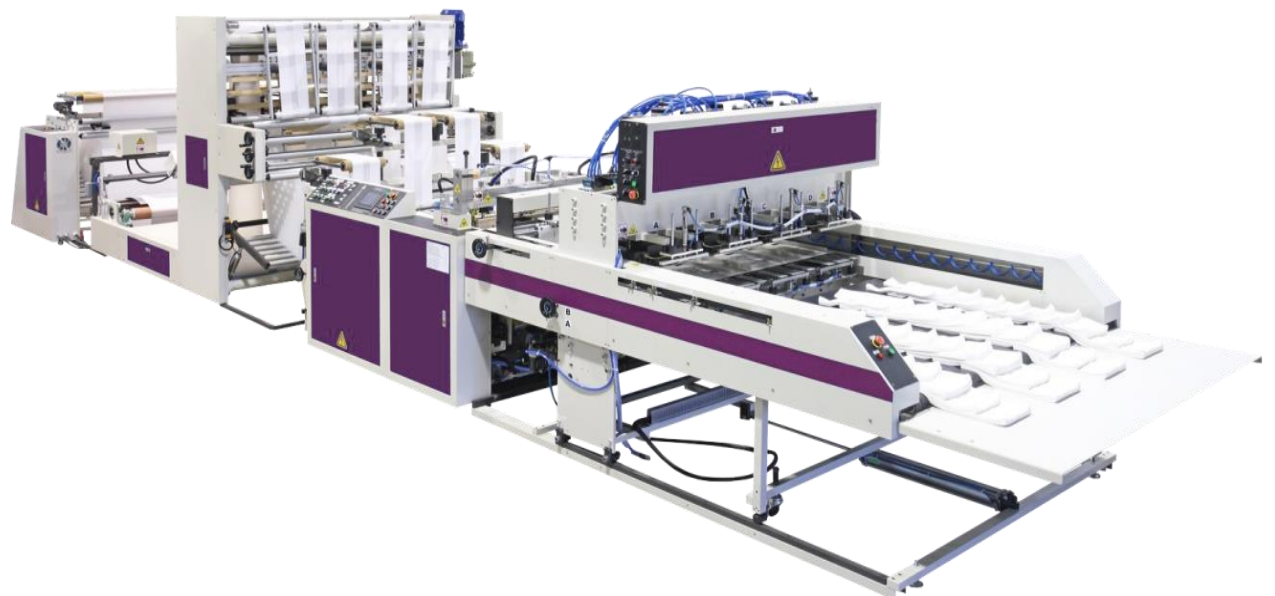
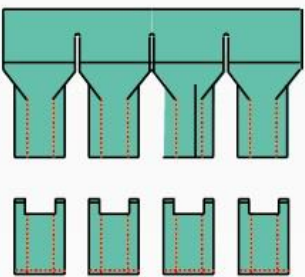

MSR-40L2

Fully auto non-tension Star-seal bags on roll (Coreless) making machine

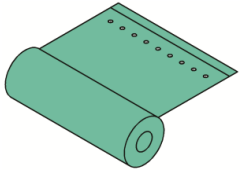

MSCR-40L2

Fully auto two track Flat bags on roll (with core) making machine

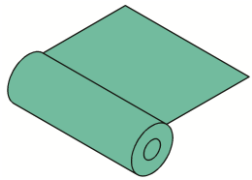

MSCR-40ST2

Fully auto two track Flat bags on roll (with core) making machine + Hot-Slitter

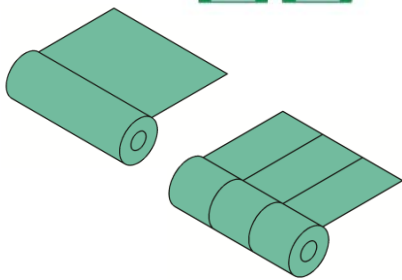
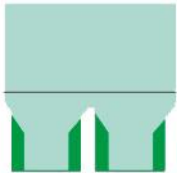

MBCROS-40L2

Fully auto two track T-shirt bags / Flat bags on roll (with core) making machine

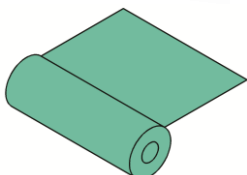
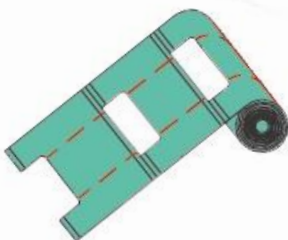

MBCROS-40ST2

Fully auto two track T-shirt bags / Flat bags on roll (with core) making machine

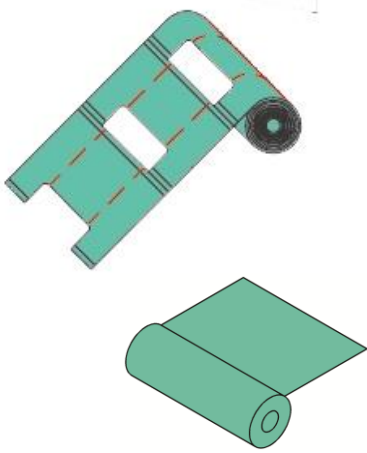

MSBCR-32

Fully auto one track Laundry bags / Flat bags / Garbage bags / Table cover on roll (with core) making machine

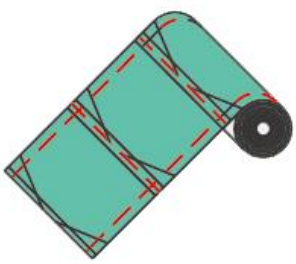

MTRCR-40L2

Fully auto two track bags on roll making machine

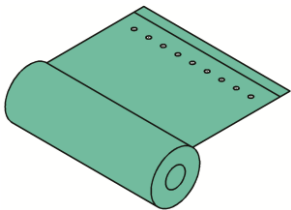

MSMNR

Fully auto Garbage bags / Table cover on roll (Coreless) making machine with C/M/N/V folding device

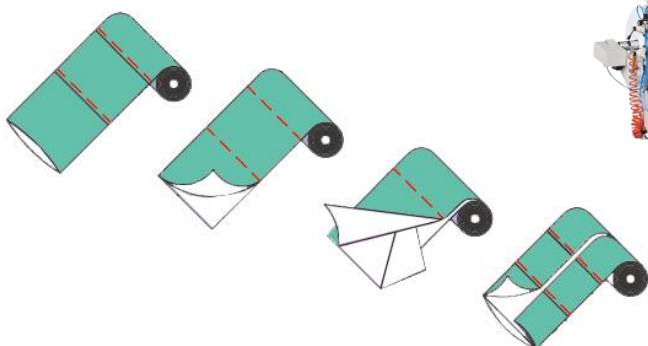

MRCR-L2

Fully auto two track bags on roll making machine

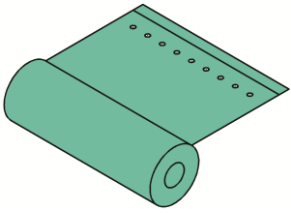

MSWCR-350L2 / MSWCR-500L2

Two tracks fully auto 4 spindles stretch film re-winder



MSSIR-300L2

Two track semi-auto Inter-leaved Star-seal Bags / Flat bags on roll making machine

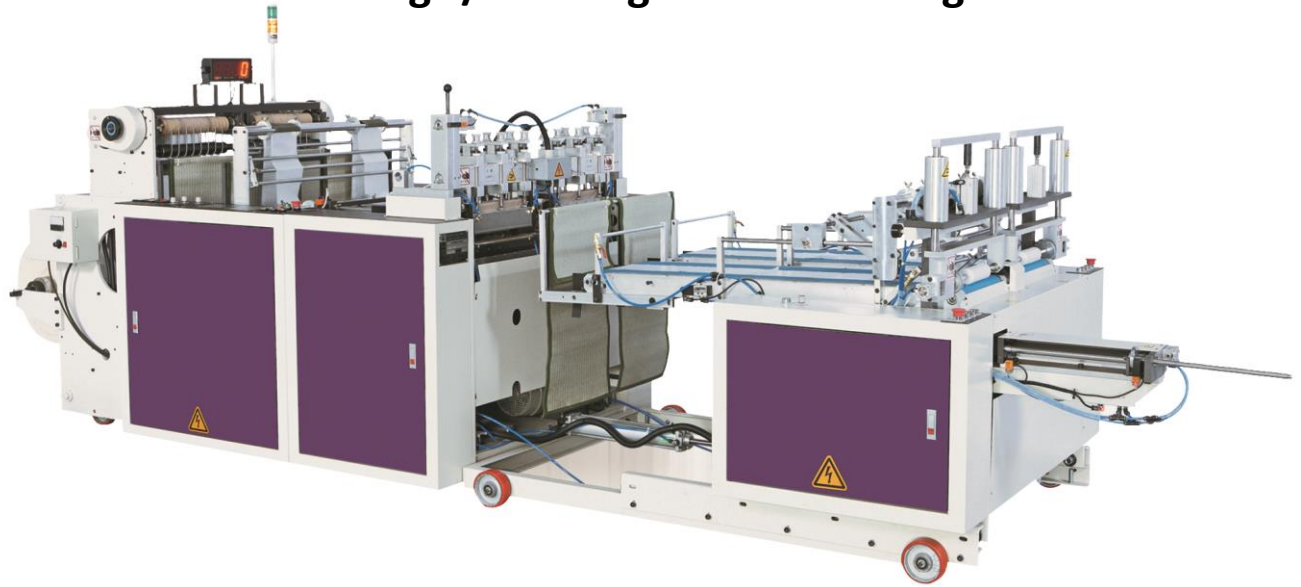
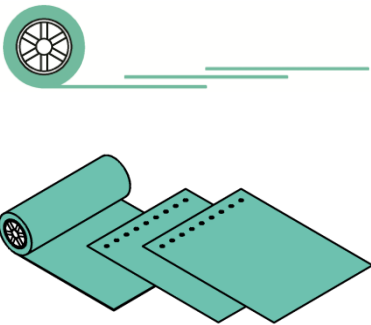

MSIR-400L2

Two track auto Inter-leaved Star-seal bags / Flat bags on roll making machine

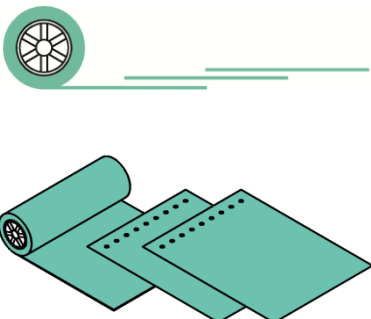

MSOSR-1000

Fully auto one track Flat bags / Star seal bags / S cut bags on roll making machine

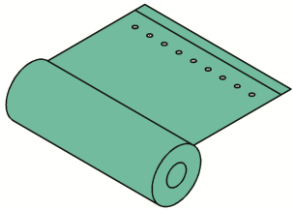

MZP-S

Zipper Bags Cutting & Sealing Machine



MSTB

Auto T-shirt / Flat bags making machine + Three fold unit



MBC-SS

Dual Servo Flat bags / T-shirt bags making machine



MBCP-SS

Dual servo automatic Flat bags / T-shirt bags making machine

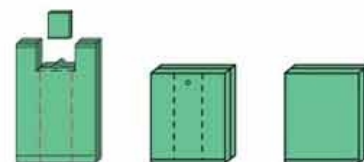

MDHL

Fully Automatic DHL Courier Bags Making Machine

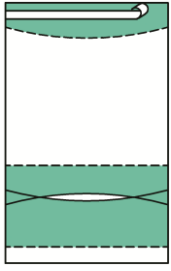

MFF-S

Three Servo Non-Tension Heavy Gauge Bags Making Machine

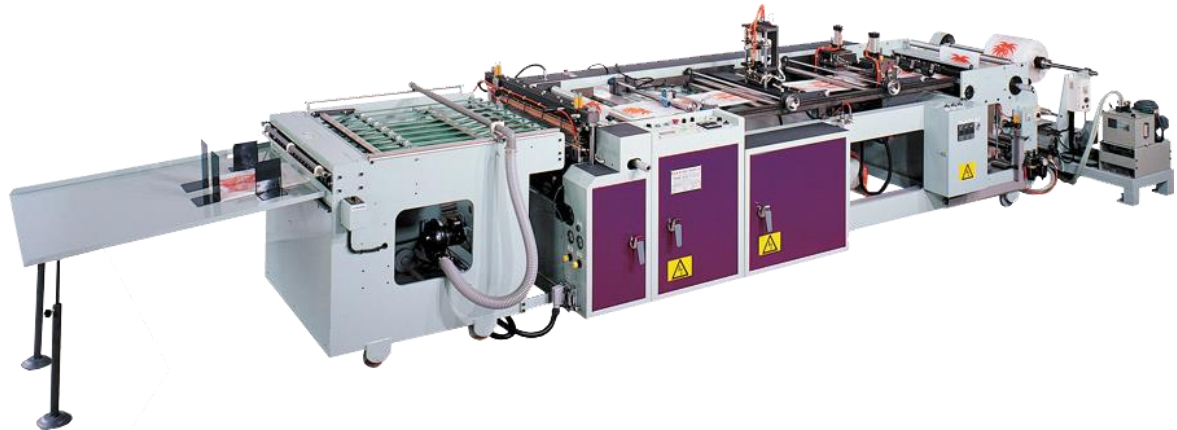
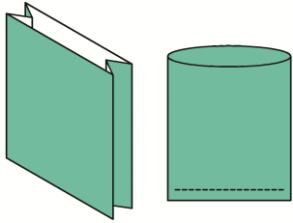

MS-S

Multi-Function Side Sealing Bags Making Machine

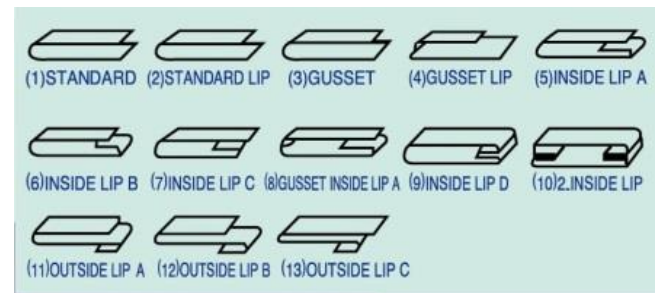

MSPH

High Speed Fully Automatic Patch-Handle Bags Making Machine

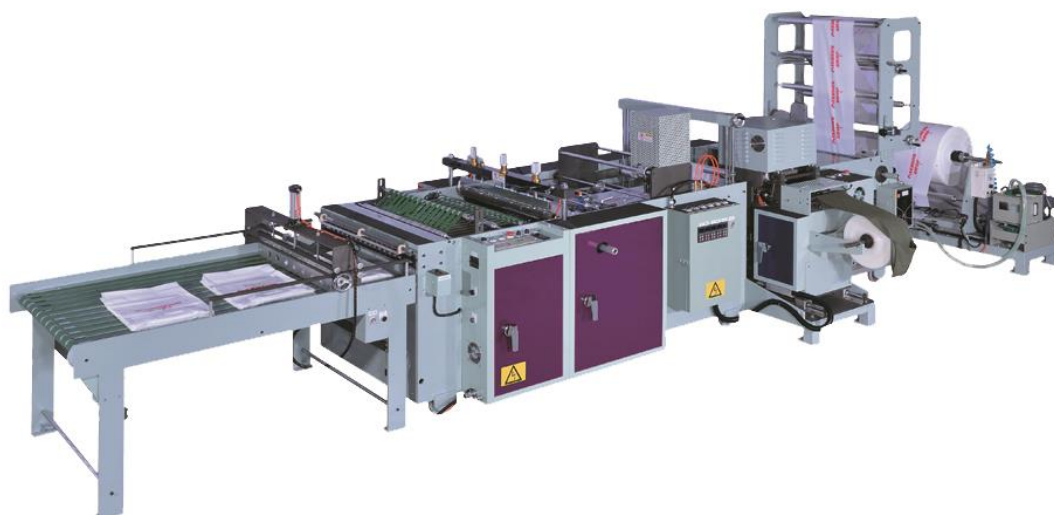

MSP

Fully Automatic Patch-Handle Bags Making Machine

MSLH

Fully Automatic Soft-Loop-Handle Bags Making Machine

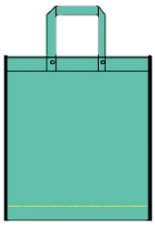

MSLPDD

4 in 1 Fully Automatic Soft-Loop-Handle /Patch-Handle /Die-cut / Draw-tape Bags Making Machine

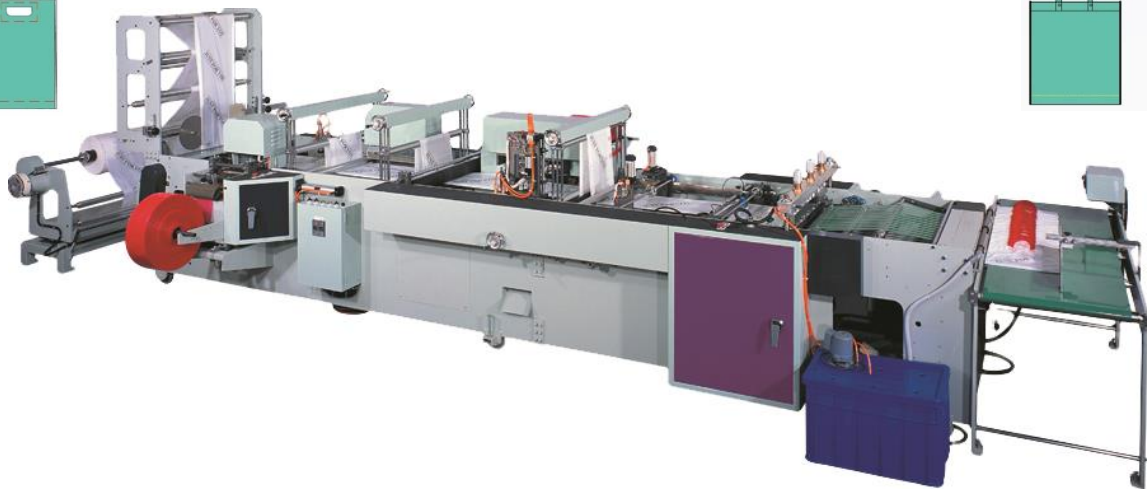

MSLDD

3 in 1 Fully Automatic Soft-Loop-Handle /Die-cut / Draw-tape Bags Making Machine



MSPDD

3 in 1 Fully Automatic Patch-Handle / Die-cut / Draw-tape Bags Making Machine



MSPDF

Poly Draw Tape Garbage Bags Making Machine With MN4 In-line Folding Device

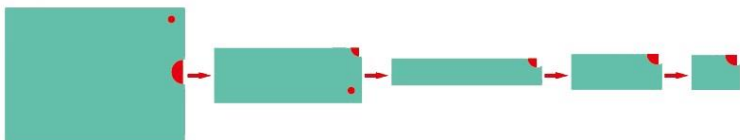

MHW

High Speed Side Sealing Machine with Wicketer



MSW

High Speed Triangle Folding & Re-winding Machine



MHSW

Hot Slitting & Sealing Re-tube & Re-winding Machine



SLH

Semi-Automatic Soft Loop Handle Bags Making Machine

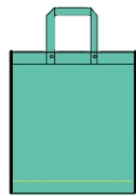

MDC

Manual Operation Die Punching Unit



MT

Semi-automatic one track T-shirt bags making machine



MTT

Semi-automatic two track T-shirt bags making machine



MDP

Fully Automatic Side Sealing Diaper Bags Making Machine

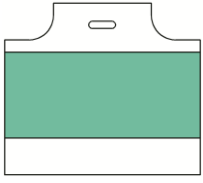

MDPW

Fully Automatic Side Sealing Diaper Bags Making Machine With Wicketer

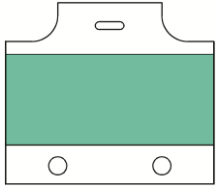

MDPP

Fully Automatic Patch Handle Diaper Bags Making Machine

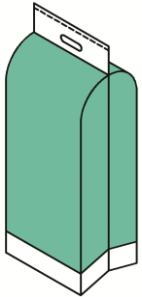

MSHGL

Fully auto disposable gloves making machine

